

650V Super Junction Power MOSFET

- ★ Super Low Gate Charge
- ★ 100% EAS Guaranteed
- ★ Green Device Available
- ★ Excellent CdV/dt effect decline
- ★ Advanced trench gate super junction technology

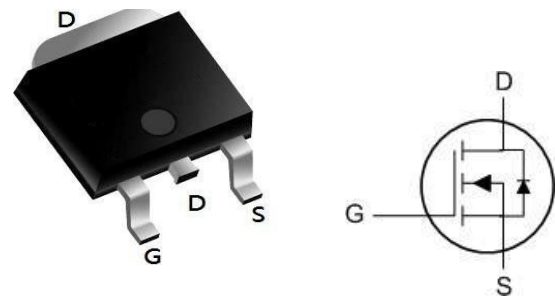

Product Summary

BVDSS	R _{DS(ON)}	I _D
650V	0.5 Ω	8 A

Description

The 650SJ520 use advanced trench gate super junction technology and design to provide excellent RDS(ON) with low gate charge. This super junction MOSFET fits the industry's AC-DC SMPS requirements for PFC, AC/DC power conversion, and industrial power applications.

The 650SJ520 meet the RoHS and Green Product requirement, 100% EAS guaranteed with full function reliability approved.

TO252 Pin Configuration

Absolute Maximum Ratings

Parameter	Sym			Unit
Drain-source voltage	V _{DSS}	650		V
Continuous drain current ¹⁾ (T _C = 25°C)	I _D	8		A
		4.8		A
Pulsed drain current ²⁾	I _{DM}	19		A
Gate-source voltage	V _{GS}	±30		V
Avalanche energy, single pulse ³⁾	E _{AS}	45		mJ
Avalanche energy, repetitive ²⁾	E _{AR}	0.15		mJ
Avalanche current, repetitive ²⁾	I _{AR}	1.0		A
Power dissipation (T _C = 25°C) - Derate above 25°C	P _D	57	27	W
		0.46	0.22	W/°C
Operating and storage temperature range	T _j , T _{stg}	-55 to +150		°C
Continuous diode forward current	I _S	8		A
Diode pulse current	I _{S,pulse}	19		A

Thermal Characteristics

Parameter	Sym			Unit
Thermal resistance, junction-to-case	R _{θJC}	2.2	4.6	°C/W
Thermal resistance, junction-to-ambient	R _{θJA}	62	80	°C/W

Electrical Characteristics $T_c = 25^\circ\text{C}$, unless otherwise noted

Parameter	Symbol	Test Condition	Min.	Typ.	Max.	Unit
Static characteristics						
Drain-source breakdown voltage	BV_{DSS}	$V_{GS}=0\text{ V}, I_D=0.25\text{ mA}$	650	-	-	V
Gate threshold voltage	$V_{GS(th)}$	$V_{DS}=V_{GS}, I_D=0.25\text{ mA}$	2	3	4	V
Drain cut-off current	I_{DSS}	$V_{DS}=650\text{ V}, V_{GS}=0\text{ V},$ $T_j = 25^\circ\text{C}$ $T_j = 125^\circ\text{C}$	-	-	1	μA
Gate leakage current, forward	I_{GSSF}	$V_{GS}=20\text{ V}, V_{DS}=0\text{ V}$	-	-	100	nA
Gate leakage current, reverse	I_{GSSR}	$V_{GS}=-20\text{ V}, V_{DS}=0\text{ V}$	-	-	-100	nA
Drain-source on-state resistance	$R_{DS(on)}$	$V_{GS}=10\text{ V}, I_D=1.5\text{ A}$ $T_j = 25^\circ\text{C}$	-	0.5	0.6	Ω
Dynamic characteristics						
Input capacitance	C_{iss}	$V_{DS}=100\text{ V}, V_{GS}=0\text{ V},$ $f = 1\text{ MHz}$	-	415	-	pF
Output capacitance	C_{oss}		-	19	-	
Reverse transfer capacitance	C_{rss}		-	0.95	-	
Turn-on delay time	$t_{d(on)}$	$V_{DD} = 300\text{ V}, I_D = 2\text{ A}$ $R_G = 25\Omega, V_{GS}=10\text{ V}$	-	12	-	ns
Rise time	t_r		-	10	-	
Turn-off delay time	$t_{d(off)}$		-	62	-	
Fall time	t_f		-	13	-	
Gate charge characteristics						
Gate to source charge	Q_{gs}	$V_{DD}=480\text{ V}, I_D=2\text{ A},$ $V_{GS}=0\text{ to }10\text{ V}$	-	1.7	-	nC
Gate to drain charge	Q_{gd}		-	3.5	-	
Gate charge total	Q_g		-	9.6	-	
Gate plateau voltage	$V_{plateau}$		-	5.2	-	V
Reverse diode characteristics						
Diode forward voltage	V_{SD}	$V_{GS}=0\text{ V}, I_F=1.5\text{ A}$	-	-	1.2	V
Reverse recovery time	t_{rr}	$V_R=50\text{ V}, I_F=2\text{ A},$ $di_f/dt=100\text{ A}/\mu\text{s}$	-	105	-	ns
Reverse recovery charge	Q_{rr}		-	0.6	-	μC
Peak reverse recovery current	I_{rrm}		-	11.3	-	A

Notes:

- Limited by $T_{j\max}$. Maximum duty cycle $D=0.5$.
- Repetitive rating: pulse width limited by maximum junction temperature.
- $I_{AS} = 1.0\text{ A}, V_{DD} = 50\text{ V}, R_G = 25\Omega$, starting $T_j = 25^\circ\text{C}$.

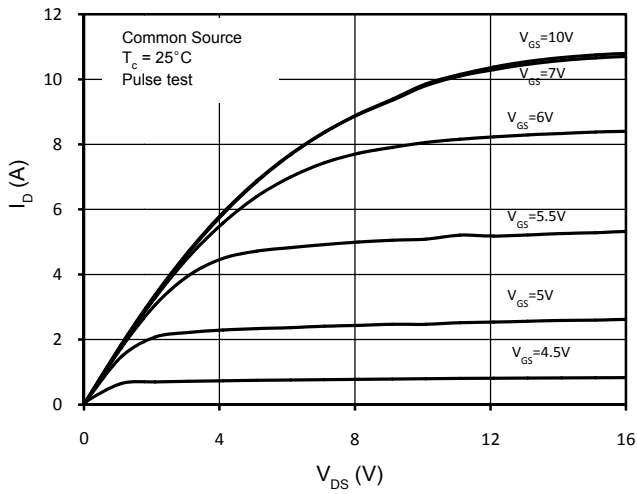
650V Super Junction Power MOSFET


Figure 1. On-Region Characteristics

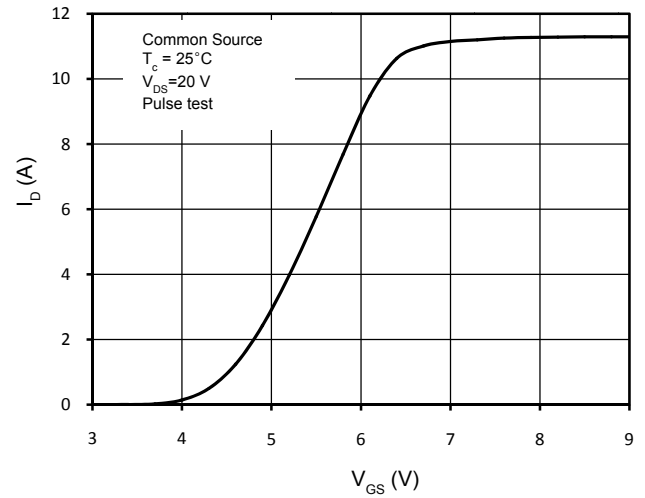


Figure 2. Transfer Characteristics

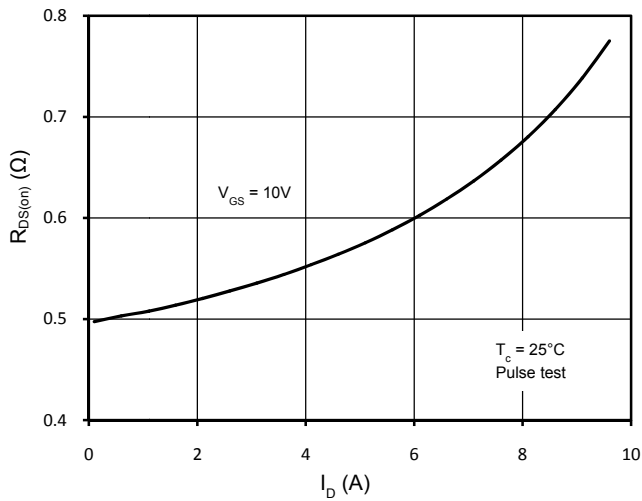


Figure 3. Static Drain-Source On Resistance

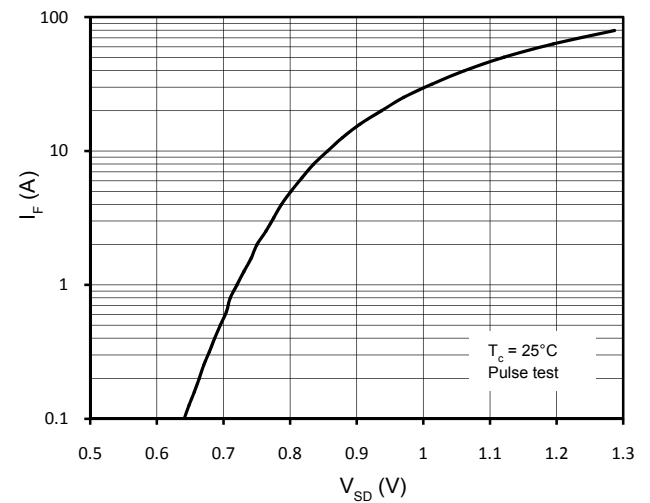
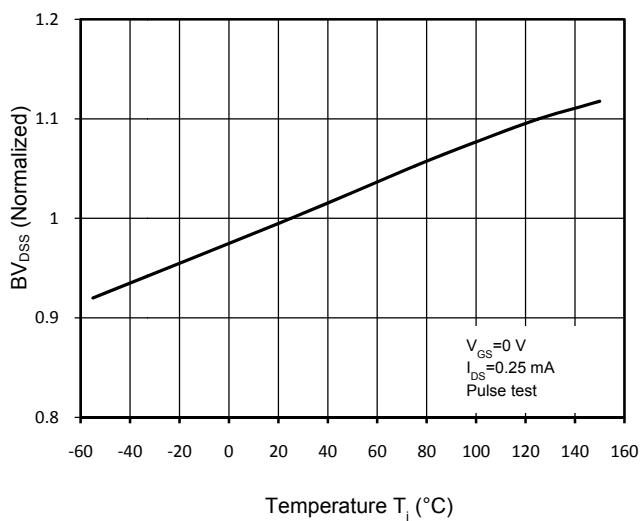
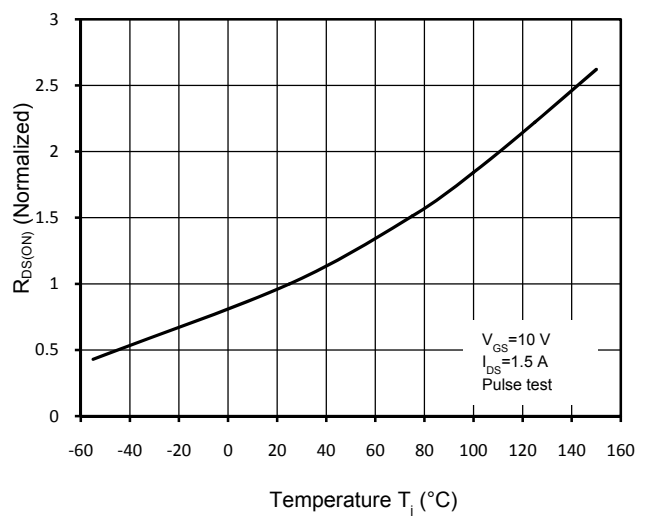


Figure 4. Body-Diode Forward Characteristics


 Figure 5. Normalized $BV_{DS(s)}$ vs. Temperature

 Figure 6. Normalized $R_{DS(on)}$ vs. Temperature

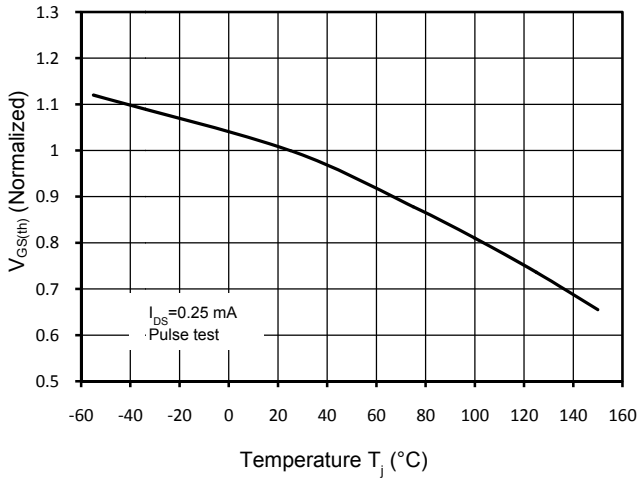
650V Super Junction Power MOSFET


Figure 7. Threshold Voltage vs. Temperature

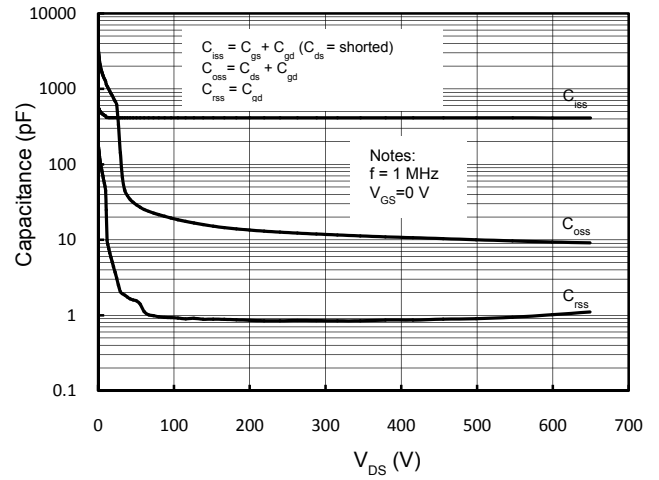


Figure 8. Capacitance Characteristics

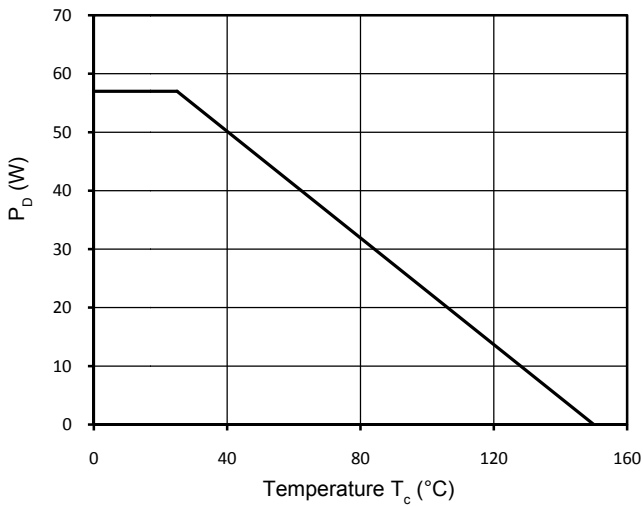


Figure 9. Power Dissipation

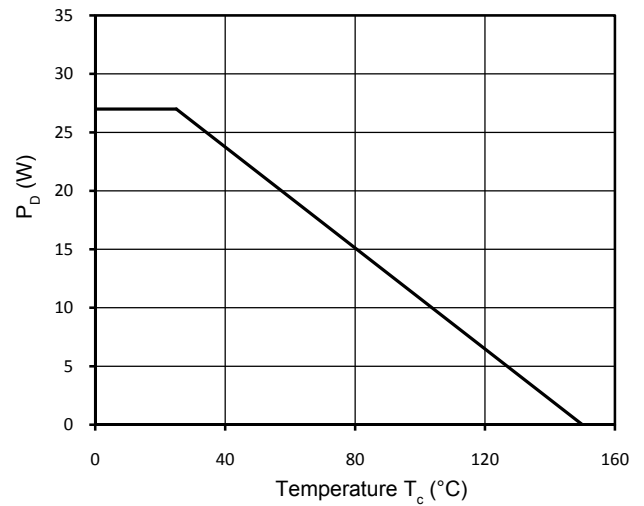


Figure 10. Power Dissipation (TO-220F)

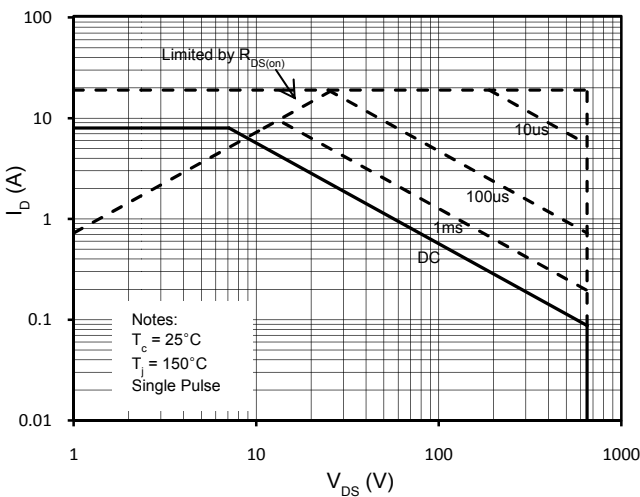


Figure 11. Maximum Safe Operating Area

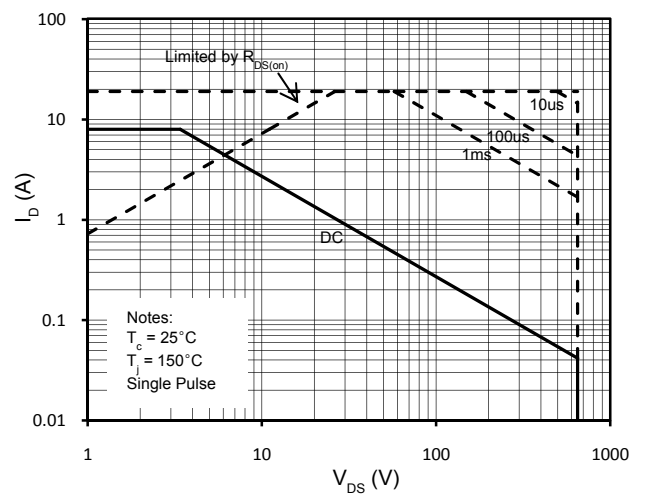


Figure 12. Maximum Safe Operating Area (TO-252)

650V Super Junction Power MOSFET

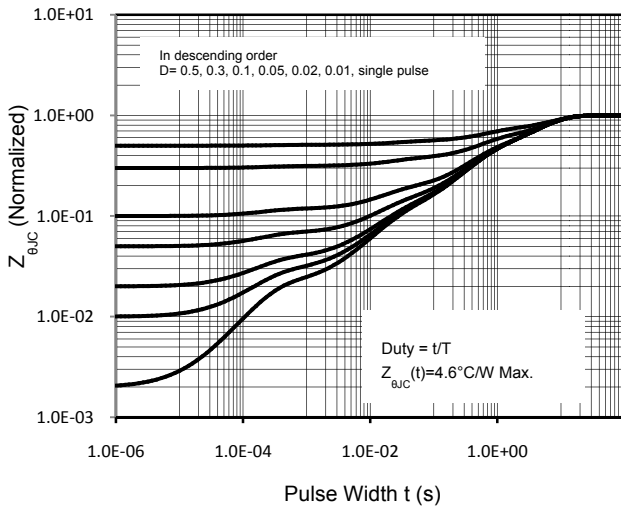


Figure 13. Transient Thermal Response Curve (TO-220F)

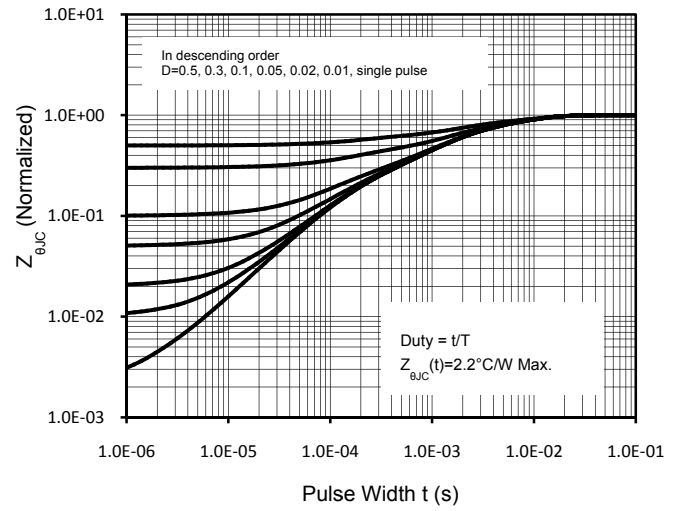


Figure 14. Transient Thermal Response Curve

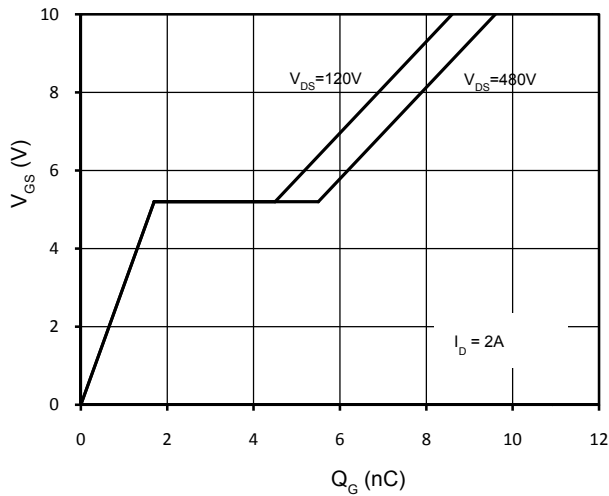
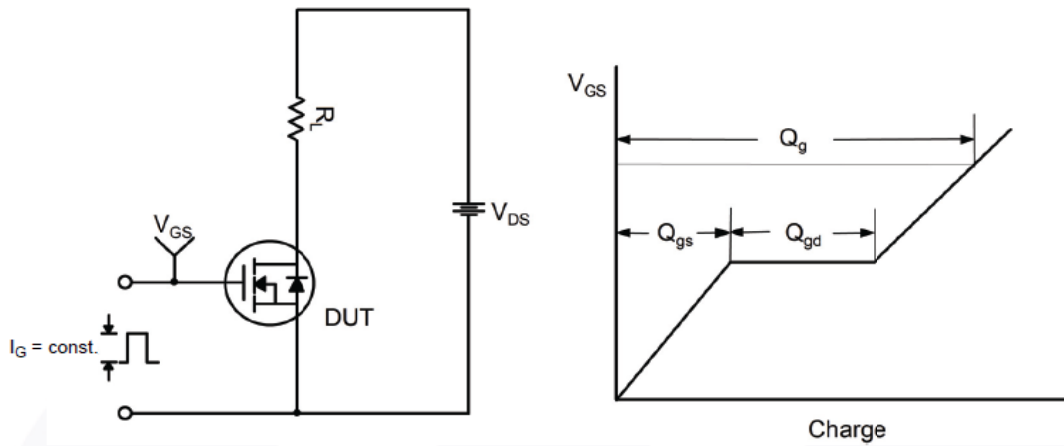
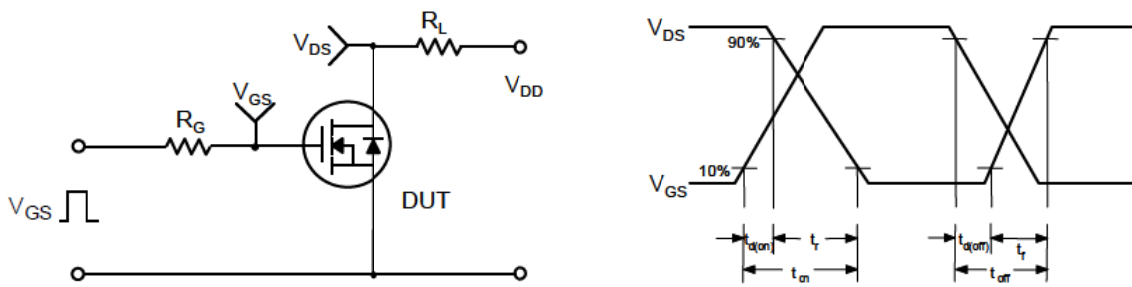


Figure 15. Gate Charge Characteristics

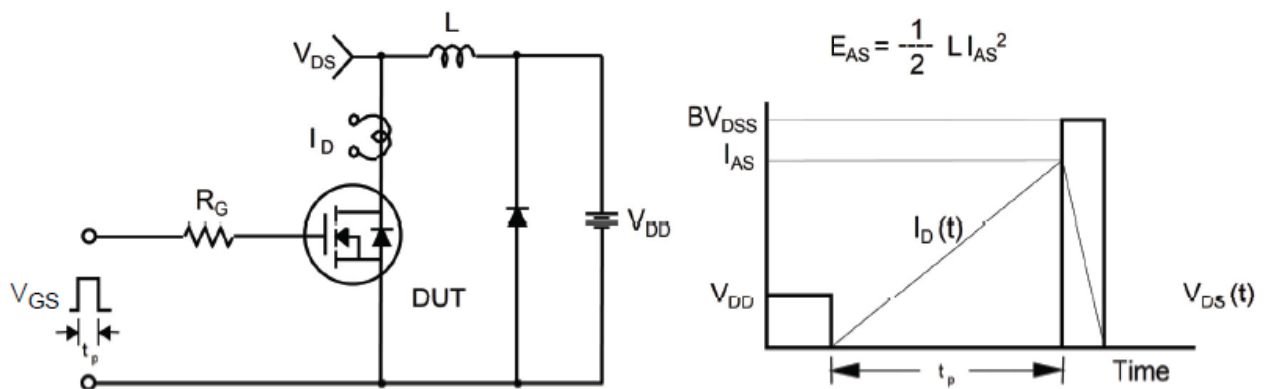
Gate Charge Test Circuit & Waveform

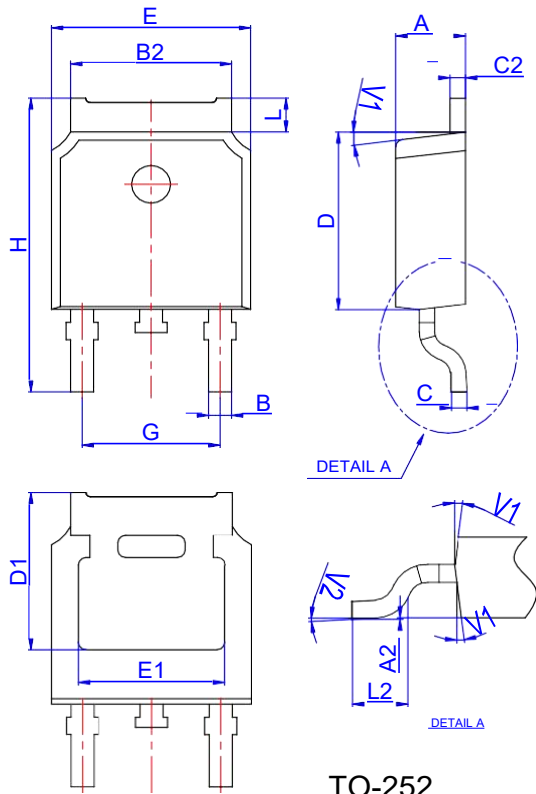


Switching Test Circuit & Waveforms

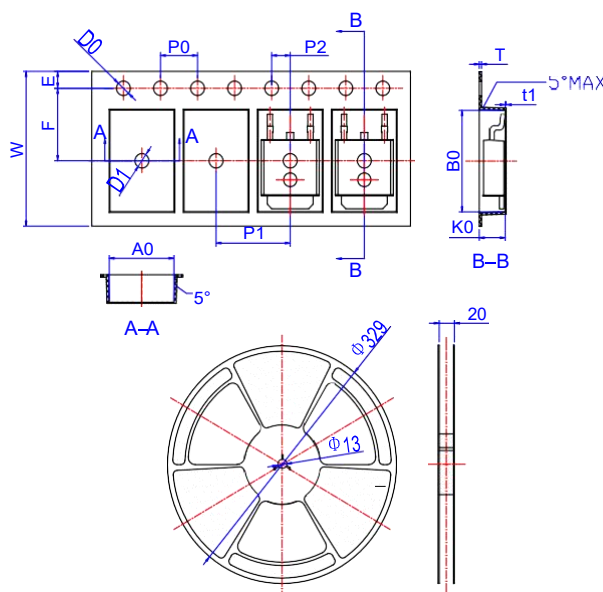


Unclamped Inductive Switching Test Circuit & Waveforms



Package Mechanical Data-TO-252


Ref.	Dimensions					
	Millimeters			Inches		
	Min.	Typ.	Max.	Min.	Typ.	Max.
A	2.10		2.50	0.083		0.098
A2	0		0.10	0		0.004
B	0.66		0.86	0.026		0.034
B2	5.18		5.48	0.202		0.216
C	0.40		0.60	0.016		0.024
C2	0.44		0.58	0.017		0.023
D	5.90		6.30	0.232		0.248
D1	5.30REF			0.209REF		
E	6.40		6.80	0.252		0.268
E1	4.63			0.182		
G	4.47		4.67	0.176		0.184
H	9.50		10.70	0.374		0.421
L	1.09		1.21	0.043		0.048
L2	1.35		1.65	0.053		0.065
V1		7°			7°	
V2	0°		6°	0°		6°

Reel Specification-TO-252-4R


Ref.	Dimensions					
	Millimeters			Inches		
	Min.	Typ.	Max.	Min.	Typ.	Max.
W	15.90	16.00	16.10	0.626	0.630	0.634
E	1.65	1.75	1.85	0.065	0.069	0.073
F	7.40	7.50	7.60	0.291	0.295	0.299
D0	1.40	1.50	1.60	0.055	0.059	0.063
D1	1.40	1.50	1.60	0.055	0.059	0.063
P0	3.90	4.00	4.10	0.154	0.157	0.161
P1	7.90	8.00	8.10	0.311	0.315	0.319
P2	1.90	2.00	2.10	0.075	0.079	0.083
A0	6.85	6.90	7.00	0.270	0.271	0.276
B0	10.45	10.50	10.60	0.411	0.413	0.417
K0	2.68	2.78	2.88	0.105	0.109	0.113
T	0.24		0.27	0.009		0.011
t1	0.10			0.004		
10P0	39.80	40.00	40.20	1.567	1.575	1.583