

- ★ Green Device Available
- ★ Super Low Gate Charge
- ★ Excellent CdV/dt effect decline
- ★ Advanced high cell density Trench technology

Product Summary

BVDSS	R _{DS(on)}	I _D
30V	6.5mΩ	50A

Description

The XXW50N03F is the high cell density trenched N-ch MOSFETs, which provide excellent R_{DS(on)} and gate charge for most of the synchronous buck converter applications. The XXW50N03F meet the RoHS and Green

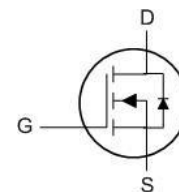
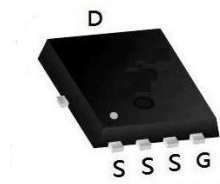
PRPAK5X6 Pin Configuration

Absolute Maximum Ratings

Symbol	Parameter	Rating	Units
V _{DS}	Drain-Source Voltage	30	V
V _{GS}	Gate-Source Voltage	±20	V
I _D @T _C =25°C	Continuous Drain Current, V _{GS} @ 10V ¹	50	A
I _D @T _C =100°C	Continuous Drain Current, V _{GS} @ 10V ¹	30	A
I _{DM}	Pulsed Drain Current ²	120	A
EAS	Single Pulse Avalanche Energy ³	39	mJ
I _{AS}	Avalanche Current	50	A
P _D @T _C =25°C	Total Power Dissipation ⁴	20	W
T _{STG}	Storage Temperature Range	-55 to 150	°C
T _J	Operating Junction Temperature Range	-55 to 150	°C

Thermal Data

Symbol	Parameter	Typ.	Max.	Unit
R _{θJA}	Thermal Resistance Junction-ambient ¹	---	75	°C/W
R _{θJC}	Thermal Resistance Junction-Case ¹	---	4.32	°C/W

N-Ch 30V Fast Switching MOSFETs
Electrical Characteristics (T_J=25 °C, unless otherwise noted)

Symbol	Parameter	Conditions	Min.	Typ.	Max.	Unit
BV _{DSS}	Drain-Source Breakdown Voltage	V _{GS} =0V, I _D =250uA	30	---	---	V
ΔBV _{DSS} /ΔT _J	BVDSS Temperature Coefficient	Reference to 25°C, I _D =1mA	---	0.027	---	V/°C
R _{DS(ON)}	Static Drain-Source On-Resistance ²	V _{GS} =10V, I _D =12A	---	6.5	8.5	mΩ
		V _{GS} =4.5V, I _D =10A	---	10	14	
V _{GS(th)}	Gate Threshold Voltage	V _{GS} =V _{DS} , I _D =250uA	1.0	---	2.5	V
ΔV _{GS(th)}	V _{GS(th)} Temperature Coefficient		---	-5.8	---	mV/°C
I _{DSS}	Drain-Source Leakage Current	V _{DS} =24V, V _{GS} =0V, T _J =25°C	---	---	1	uA
		V _{DS} =24V, V _{GS} =0V, T _J =55°C	---	---	5	
I _{GSS}	Gate-Source Leakage Current	V _{GS} =±20V, V _{DS} =0V	---	---	±100	nA
R _g	Gate Resistance	V _{DS} =0V, V _{GS} =0V, f=1MHz	---	1.7	---	Ω
Q _g	Total Gate Charge (4.5V)	V _{DS} =20V, V _{GS} =4.5V, I _D =12A	---	12.8	---	nC
Q _{gs}	Gate-Source Charge		---	3.3	---	
Q _{gd}	Gate-Drain Charge		---	6.5	---	
T _{d(on)}	Turn-On Delay Time	V _{DD} =12V, V _{GS} =10V, R _G =3.3Ω I _D =5A	---	4.5	---	ns
T _r	Rise Time		---	10.8	---	
T _{d(off)}	Turn-Off Delay Time		---	25.5	---	
T _f	Fall Time		---	9.6	---	
C _{iss}	Input Capacitance	V _{DS} =15V, V _{GS} =0V, f=1MHz	---	1200	---	pF
C _{oss}	Output Capacitance		---	163	---	
C _{rss}	Reverse Transfer Capacitance		---	131	---	

Diode Characteristics

Symbol	Parameter	Conditions	Min.	Typ.	Max.	Unit
I _S	Continuous Source Current ^{1,6}	V _G =V _D =0V, Force Current	---	---	50	A
I _{SM}	Pulsed Source Current ^{2,6}		---	---	120	A
V _{SD}	Diode Forward Voltage ²	V _{GS} =0V, I _S =1A, T _J =25°C	---	---	1.2	V

Note :

1. The data tested by surface mounted on a 1 inch² FR-4 board with 20Z copper.
2. The data tested by pulsed, pulse width ≤ 300us, duty cycle ≤ 2%
3. The EAS data shows Max. rating. The test condition is V_{DD}=25V, V_{GS}=10V, L=0.1mH, I_{AS}=34A
4. The power dissipation is limited by 150°C junction temperature
5. The data is theoretically the same as I_D and I_{DM}, in real applications, should be limited by total power dissipation.

Typical Characteristics

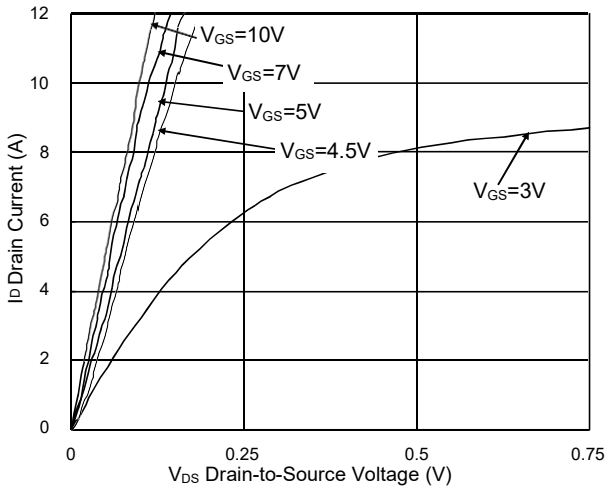

Fig.1 Typical Output Characteristics

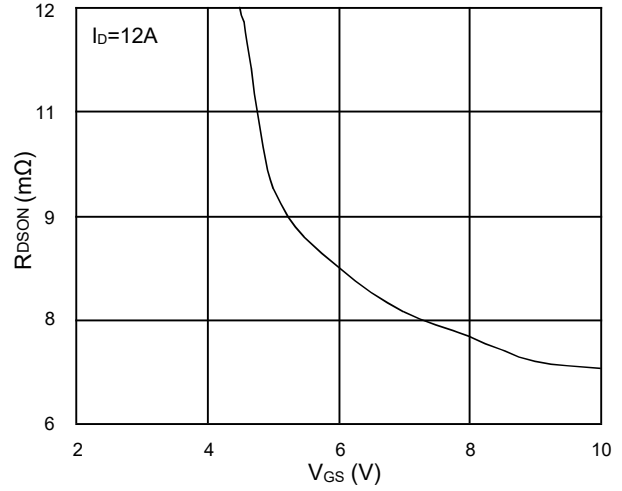

Fig.2 On-Resistance vs. G-S Voltage

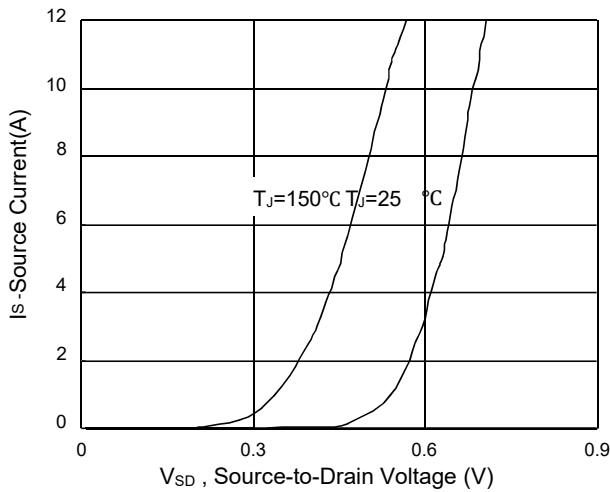

Fig.3 Forward Characteristics of Reverse

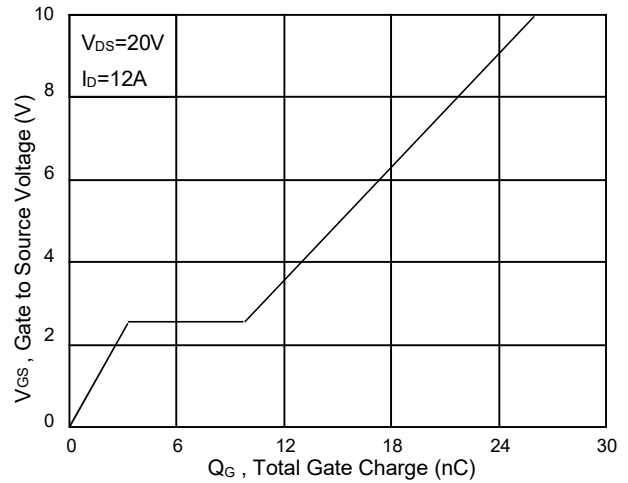

Fig.4 Gate-Charge Characteristics

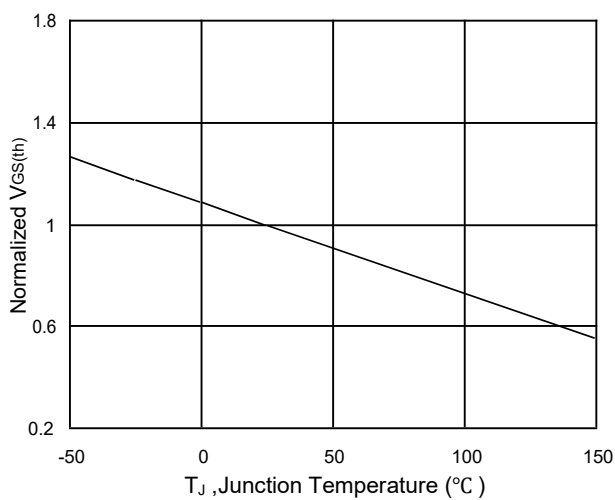

Fig.5 Normalized $V_{GS(th)}$ vs. T_J

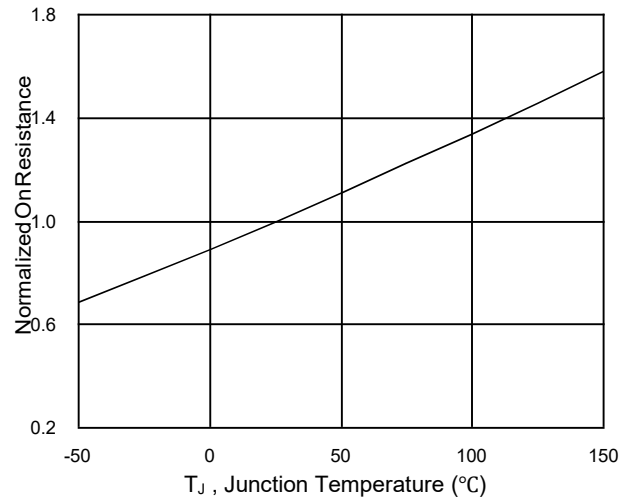
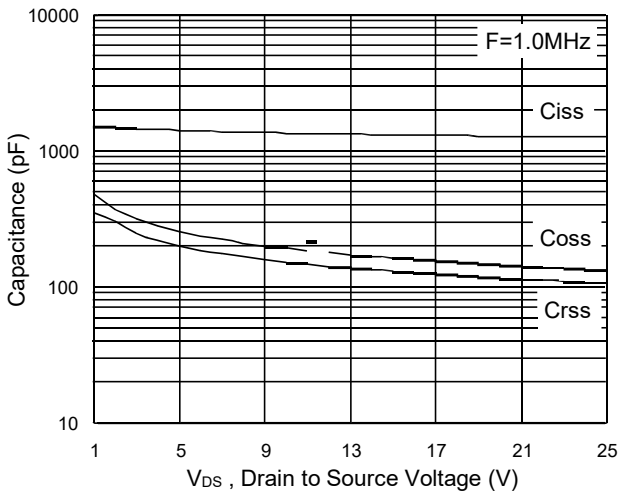
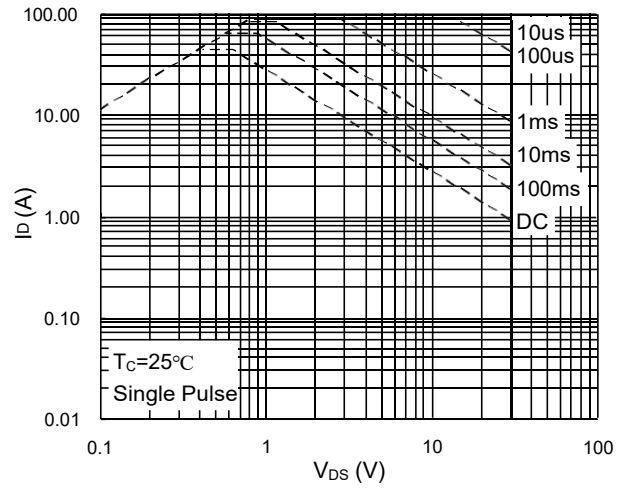
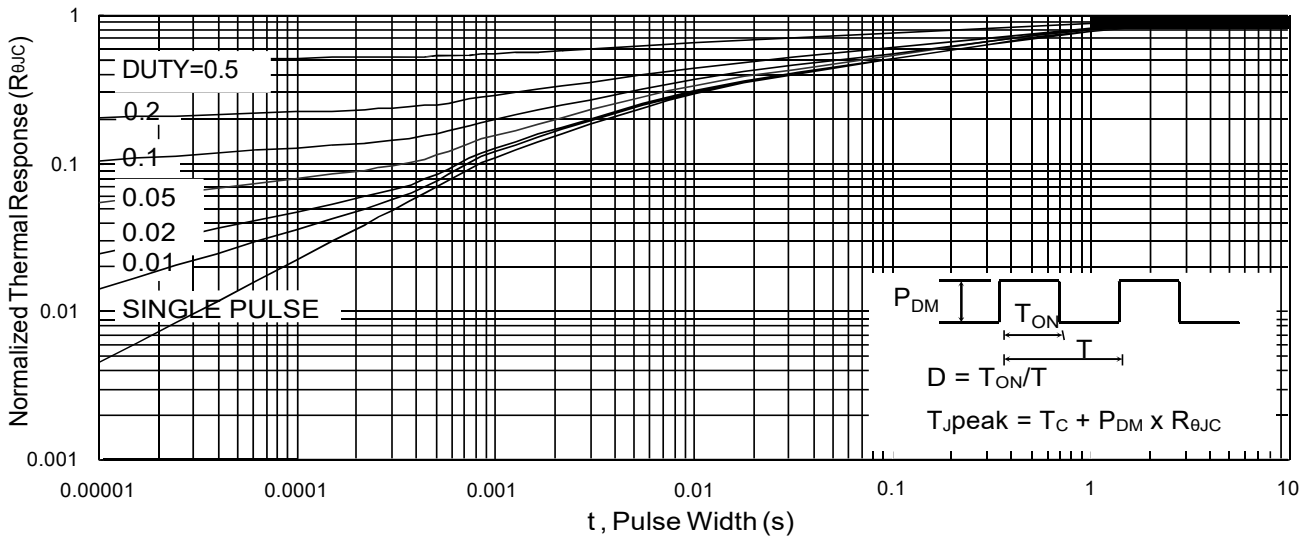
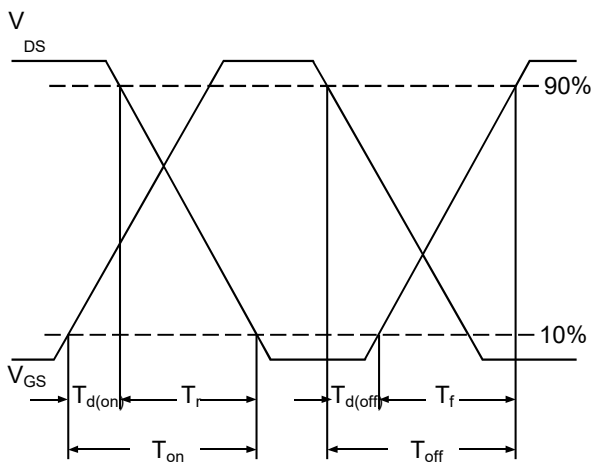
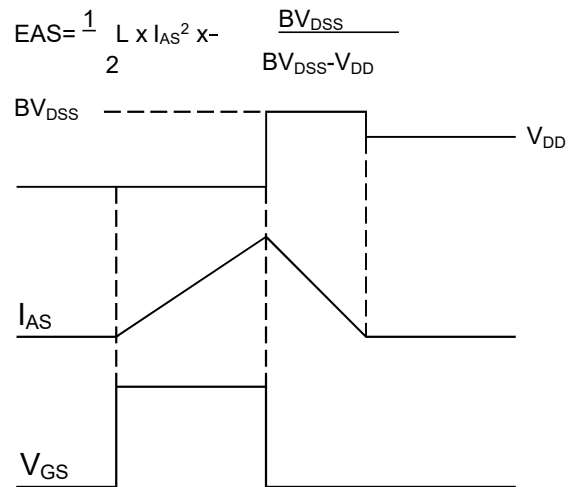
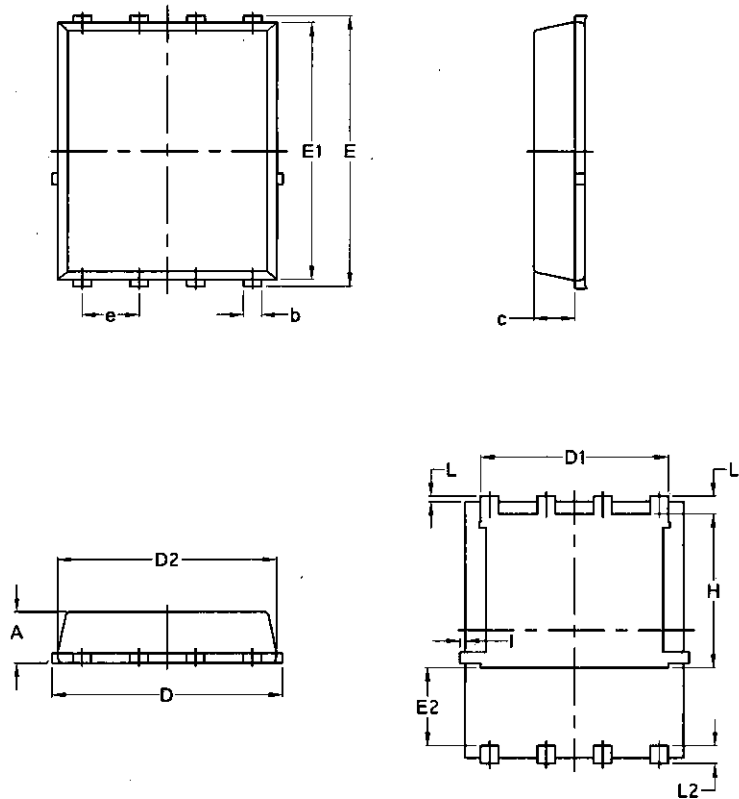

Fig.6 Normalized $R_{DS(on)}$ vs. T_J

N-Ch 30V Fast Switching MOSFETs

Fig.7 Capacitance

Fig.8 Safe Operating Area

Fig.9 Normalized Maximum Transient Thermal Impedance

Fig.10 Switching Time Waveform

Fig.11 Unclamped Inductive Switching Waveform

Package Mechanical Data-DFN5*6-8L-JQ Single

Symbol	Common			
	mm		Inch	
	Min	Max	Min	Max
A	1.03	1.17	0.0406	0.0461
b	0.34	0.48	0.0134	0.0189
c	0.824	0.0970	0.0324	0.082
D	4.80	5.40	0.1890	0.2126
D1	4.11	4.31	0.1618	0.1697
D2	4.80	5.00	0.1890	0.1969
E	5.95	6.15	0.2343	0.2421
E1	5.65	5.85	0.2224	0.2303
E2	1.60	/	0.0630	/
e	1.27 BSC		0.05 BSC	
L	0.05	0.25	0.0020	0.0098
L1	0.38	0.50	0.0150	0.0197
L2	0.38	0.50	0.0150	0.0197
H	3.30	3.50	0.1299	0.1378
I	/	0.18	/	0.0070